

General Information

On Receipt

It is our policy to promote safe delivery of all orders. This product shipment has been thoroughly checked, packed and quality certified before leaving our factory.

Visible Loss or Damage

If any of the goods called for on the bill of lading or express receipt are damaged or the quantity is short, do not accept them until the freight or express delivery agent makes an appropriate notation on your freight bill or receipt.

Concealed Loss or Damage

When a shipment has been delivered to you in apparent good condition, but upon opening the packaging if any loss or damage has taken place while in transit, inform the carrier's agent / A. O. Smith representative immediately.

About this manual

This manual is a guide to good practice for operating and periodic maintenance of the A. O. Smith Urbane Water Heater. Do not operate the Water Heater before reading the user manual.

Please follow instructions in this manual to ensure personal safety and proper operation of this product. Always install, operate, inspect and maintain this product in accordance with all applicable standards. Please store this user manual carefully for any future reference.

Disposal of this Product

(Waste Electrical and Electronic Equipment)



This marking on the product, accessories or User Manual indicates that the product and its electronic accessories (e.g. Remote, batteries and other replaceable electronic accessories) should not be disposed of with other household waste at the end of their working life. To prevent possible harm to the environment or human health from uncontrolled waste disposal, please separate these items from other types of waste and recycle them responsibly to promote the sustainable re-use of material resources.

Household users should contact their local government office, for details of where and how they can take these items for environmentally safe recycling. This product and its electronic accessories should not be mixed with other commercial wastes for disposal.

1

Specifications

Model	Urbane			
Volume [L]	6	10	15	25
Power [W]	2000			
Voltage/Frequency [V/Hz]	230~/50			
Actual Stdg. Loss [kWh/24h/45°C diff.]	0.280	0.340	0.410	0.505
Reheating time for 35°C rise [in min.]	6	11	12	22
Maximum set point temperature [°C]	75*			
Rated water pressure	N/cm ²	80		
	Water head (metres)	80		
Inlet/Outlet connections [inch]	½ BSP			
Net Weight (kgs)	6.3	8.2	9.8	13

*The maximum set point temperature may vary ± 5 °C.

Dimensions

Model	6 Ltrs	10 Ltrs	15 Ltrs.	25 Ltrs.
A (mm)	317	373	373	444
B (mm)	317	373	373	444
C (mm)	100	100	100	100
D (mm)	85	95	125	125
E (mm)	105	120	130	135
F (mm)	258	277	348	383

3

Safety Instructions

Your safety and the safety of your loved ones is paramount. There are several safety related messages in this manual, which have been provided during various steps such as the installation, operation and maintenance of your Urbane Water Heater. These messages point out potential hazards and also educate on how to reduce any potential risks. Please always read and follow all safety messages as provided in this user manual.

	This is the safety alert symbol. This symbol alerts you to potential hazards that can hurt you and others. All safety messages will follow the safety alert symbol and either the word "DANGER" or "WARNING".
	Indicates an imminently hazardous situation which, if not avoided, will result in death or serious injury.
	Indicates a potentially hazardous situation, which if not avoided, could result in death or serious injury.
	Indicates a potentially hazardous situation which, if not avoided, may result in minor or moderate injury or property damage.

WARNING

Do not use this Water Heater if any part has been under water. Immediately contact an Authorised Service Technician to inspect the Water Heater and contact A. O. Smith Service personnel to replace any part of the control system which has been under water. Failure to follow this instruction can result in property damage, serious injury or death.

IMPORTANT

These instructions have been written as a guide for the proper installation and operation of your Water Heater. A. O. Smith will not accept any liability where these instructions have not been followed. However, for your safety and to avoid damage caused by improper installation, it is recommended that Water Heater must be installed by an Authorised Service Technician.

Before proceeding with the installation instructions:

1. Inspect the Water Heater and its component parts for possible damage. Do Not install or attempt to repair any damaged component parts. If you detect any damage in the Water Heater, please contact the dealer where the Water Heater was purchased or call A. O. Smith Customer Care Centre.
2. Verify that the voltage being supplied corresponds to that which is marked on the Water Heater manual.

2

Figure 1

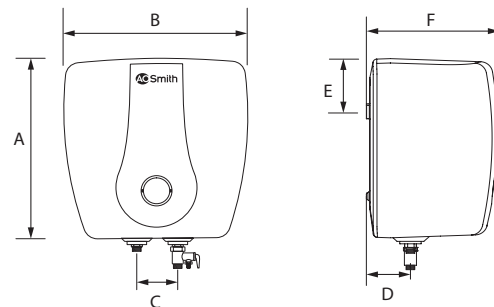
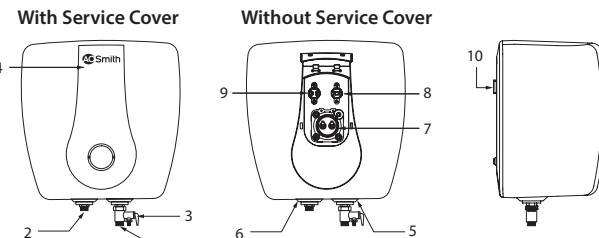

Figure 2



Part	Description
1	Cold water inlet
2	Hot water outlet
3	Multi-function Safety valve
4	Service Cover
5	Blue Cap

Part	Description
6	Red Cap
7	Heating Element and Anode
8	Thermal Cut-out
9	Thermostat
10	Wall Mount Slot

4

A. O. Smith Advantage . . .



Longer life in toughest water conditions with Blue Diamond® Glass Lined Tank.



Long lasting performance with glass coated incoloy heating element.



Long-Lasting Anode Rod with 2X lifespan even in hard water conditions..



Maximum energy savings with BEE 5 Star rating.



Double Protection of your family with Thermal Cut-out and Safety Valve.

Note: A. O. Smith reserves the right to amend or modify the specifications and features at any time, as and when required without any prior notification.



Product colour and image shown may vary from the actual product.
Part No. : 335271-112_A Date: 06-08-2021

Safety Precautions

During Installation

Do not install the Water Heater where there is direct sunlight or rain. It is has to be installed indoor only.

Figure 3

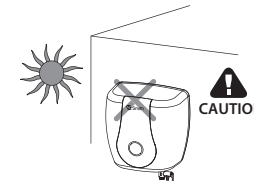

Do not install the Water Heater where water splashes on the Water Heater.

Figure 4

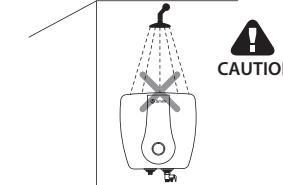

Installation

Before installing, ensure the tools Adjustable wrench, Teflon tape, Measuring tape, Hammer, Bubble level indicator and Impact drill tool are available.

Mounting the Water Heater

- It is recommended as per IS 302-1 to have 6 inches clearance from wall.
- Select a place to mount Water Heater vertically with water connection at the bottom.

Figure 5

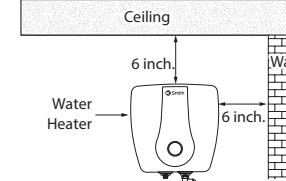

- Water Heater must be located within 3 ft. (approx.) from a 230 V electrical outlet with proper grounding.
- Make sure that the wall can withstand at least twice the weight of the Water Heater when completely filled with water.

Figure 6

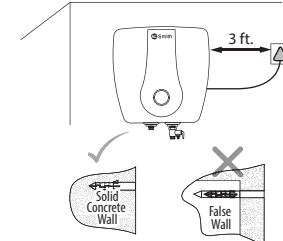

5

ACSmith
Innovation has a name.

Water Heater Urbane
6, 10, 15 and 25 Litres

Urbane



User Manual

1. Use Mounting Template to mark holes (Step 1).
2. Use a drill bit with diameter of 10 mm to drill 2 holes at least 60 mm deep in the wall (Step 3). The two holes should be aligned horizontally.

Figure 7

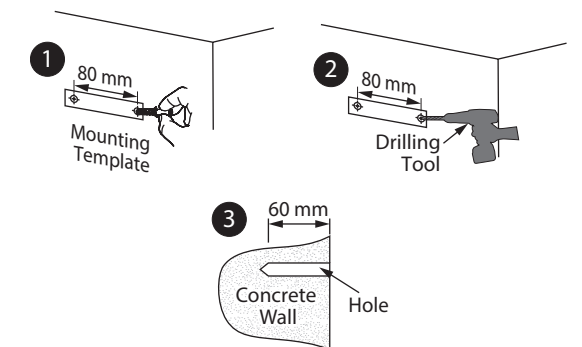

1. Insert the Expansion Anchor into the hole (Step 1).
2. Insert the Mounting screw over the Expansion Anchor and tighten the Mounting screw by rotating it till it gets fixed steadily (Step 2).

Figure 8

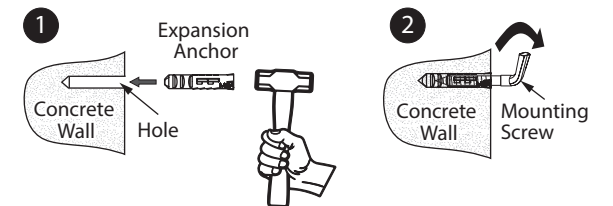

6

Mount the Water Heater on the Mounting screw through the Wall mount slot. Tug downwards on the Water Heater to ensure that the Water Heater is fixed steadily on the Wall mount bracket.

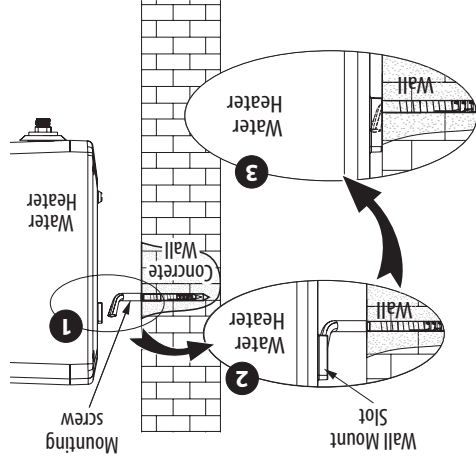
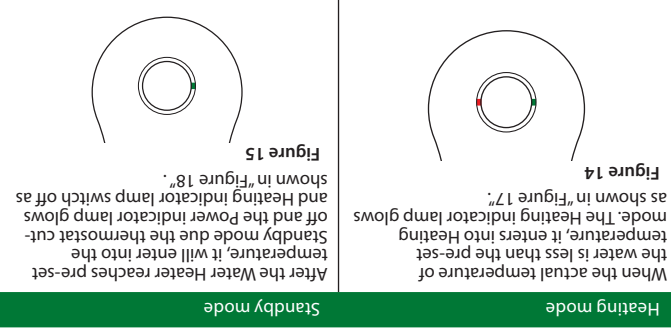

Figure 9

Modes
There are two types of modes depending on the actual water temperature inside the inner tank of the Water Heater:



When the actual temperature of the Water Heater reaches pre-set temperature, it will enter into the Heating mode due the thermostat cut-off and the Power indicator lamp glows as shown in "Figure 17".

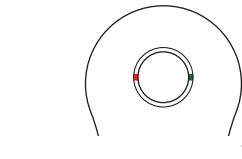

Figure 14
When the actual temperature of the Water Heater reaches pre-set temperature, it will enter into the Heating mode due the thermostat cut-off and the Power indicator lamp glows as shown in "Figure 17".

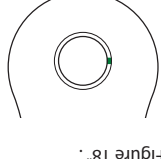
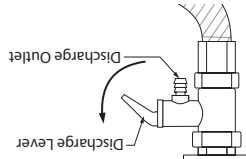

Figure 15
When the actual temperature of the Water Heater reaches pre-set temperature, it will enter into the Heating mode due the thermostat cut-off and the Power indicator lamp glows as shown in "Figure 18".

When the temperature of the water drops by 5°C from the set temperature due to usage of water, the Water Heater again enters into the Heating mode.

Draining the Water Heater Tank

Whenever the Water Heater is not used for an extended period or if the product is below freezing temperature, you will need to unplug the unit and drain it.



1. Switch OFF the electric supply to the Water Heater.
2. Open the hot water faucet until the water runs cool.
3. Close cold water supply.
4. Drain the water by lifting the Discharge Lever of the Multi-function Safety valve upwards. (Refer "Figure 19")

Figure 16

Plumbing Instructions

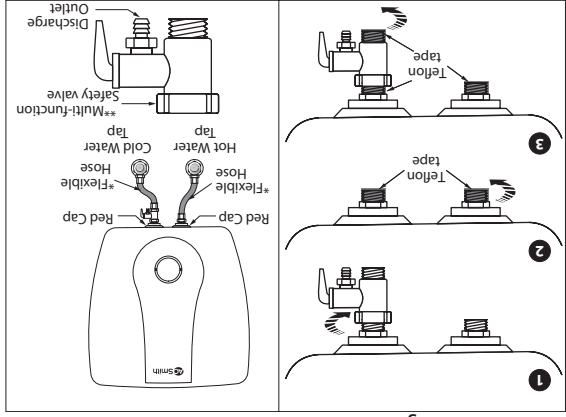

Figure 10 Installation Diagram

*Flexible Hoses to be procured by the customer, not part of standard product.

- **Multi-function Safety valve (MFSV) comes included with the Water Heater.
- 1. Remove MFSV from the inlet pipe by rotating it in anti-clockwise direction.
- 2. Wrap the Teflon tape around the inlet and outlet connections of the Water Heater to prevent leakage.
- 3. Connect MFSV to the inlet pipe by hand tightening it in clockwise direction.
- 4. Make necessary plumbing with reference to the Installation Diagram. (Refer "Installation Diagram")
- 5. Connect the cold water pipe to the inlet [Blue Cap].
- 6. Connect the hot water pipe to the outlet [Red Cap].

- Make sure to connect Multi-function Safety valve to the Water Heater before connecting inlet to the cold water tap.
- A. O. Smith recommends Nylon/ Stainless Steel (SS) braided hoses (Flexible Hoses) having a minimum pressure rating of 8 Bar and hoses should be compatible for hot water applications.
- The Multi-function Safety valve may drip during the usage of the heater. As the water is heated, it expands and tries to flow back through the inlet pipe, but is prevented by the presence of the non-return valve (an external valve provided before the water tap). Hence water may drip from the Multi-function Safety valve. Therefore, Discharge outlet is provided to discharge water from the Water Heater. To avoid dripping, it is recommended to install non-return valve at a distance of at least 40 feet away from the inlet of the Water Heater.

8

CAUTION
Please turn off the power supply to the Water Heater prior to draining the Water Heater.



CAUTION
Hot water is dangerous, especially for the young children, aged or the disabled. The Water Heater allows you to control the temperature of your hot water. Water temperatures over 52°C can cause severe burns instantly or death from scalds. Do not leave a child or an infirm person in the bath unsupervised.

Troubleshooting

The Water Heater may not operate as desired if used incorrectly or there is a minor cause, even though the product has no fault. In these cases, check the following issues to solve simple problems without the help from the Customer Care Centre. If the problem does not solve after checking the following issues, call Customer Care Centre.

Problems	Possible Cause(s)	Solution
Power indicator lamp and Heating indicator lamp does not glow.	Thermal Cut-out has tripped or problem in internal wiring.	Call Customer Care Centre.
Power indicator lamp and Heating indicator lamp glow but no hot water.	Water Heater Safety valve malfunctioning.	Call Customer Care Centre.
Water temperature is too high.	Improper thermostat operation.	Call Customer Care Centre.
Water heats slowly.	Low voltage at supply mains.	Check voltage at supply mains.
	Scale deposition.	Call Customer Care Centre.

12

CAUTION

- The Multi-function Safety valve should never be removed or blocked by any means to prevent it from dripping or releasing the excess pressure inside the heater. Failure to do so may result in damage to the Water Heater and injures to the user. This will also make the warranty null and void.
- Discharge outlet is provided to release the discharge from the Water Heater (through the Multi-function Safety valve) in case excessive pressure is developed. The contents of the discharge from the Multi-function Safety valve may be hot and may cause burns to the users and damage nearby objects. therefore it is recommended to take pre-cautions while discharging water from the Water Heater.
- It is recommended to operate the Discharge lever in the Multi-function Safety valve on a regular basis to ensure that there are no blockages and also to remove any lime deposits that would have been formed inside the Water Heater.
- Ensure that the Water Heater is in power OFF condition when the Discharge Lever is being operated. Ensure that the water is filled completely in the Water Heater before switching it ON.
- Make sure a suitable Teflon tape is used for all plumbing connections to prevent leakage.
- Use only Nylon/ Stainless Steel (SS) braided hoses (Flexible Hoses) having a minimum pressure rating of 8 Bar and hoses should be compatible for hot water applications.
- Failure to follow this instruction can result in property damage.

Figure 11

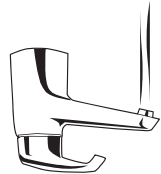

- Filling the Water Heater Tank**
1. Open a nearby hot water faucet to permit air to escape.
 2. Open the cold water inlet valve fully, filling the Water Heater and the piping.
 3. Close hot water faucet when water flows.
 4. Check all the connections to see if there is any leakage. In case of a leakage, drain the water completely, repair the leaking joint and then refill the Water Heater.

9

Problems	Possible Cause(s)	Solution
Piping connection leaks.	Connection not sealed.	Re-connect piping, using Teflon tape.
Water leakage from product.	Leakage in tank or other parts.	Switch Off power immediately and Call Customer Care Centre.
Water dripping from Multi-function Safety installed close to the inlet of the Water Heater.	Non-return valve is installed close to the inlet of the Water Heater.	Install Non-return valve at a distance of at least 40 call Customer Care Centre.
Foul smell from hot water.	Presence of organic matter in input water.	Provide treated water at the input.
No usage of hot water for a long time period	If the Water Heater is not used for an extended period of time, drain the water from the Water Heater. Ensure water is filled back before use of Water Heater.	
High electrical conductivity of water due to dissolved solids in water.	Call Customer Care Centre. Anode options available for highly conductive water.	

Note: Call Customer Care No. 1800-103-2468/1860-500-2468.

13

CAUTION

- This Water Heater should not be operated with insufficient amount of water. Failure to do so may result in damage to the Water Heater and injures to the user. This will also make the warranty null and void.
- Once the Mounting, Multi-function Safety valve, Plumbing and Water filling is completed, then only the power supply should be switched ON.
- Do not splash water directly or clean with benzene, pesticides, thinner, alcohol, etc., but use a soft, dry cloth to clean the Water Heater.

Connecting to Electrical Supply



Figure 12

- Connect the Water Heater using independent sockets, do not use any adapters. Use multimeter to check whether the live line and neutral line are not reverse, to ensure complete safety.
- Before installing the Water Heater, confirm that the power of Water Heater matches electric meter capacity and supply wire.
- The Water Heater should be earthed reliably. It is prohibited to connect the earth wire to neutral wire or faucet water pipe.
- If the power supply cord is damaged, it must be replaced by the manufacturer or Authorised Service Technician in order to avoid a hazard.

Figure 13

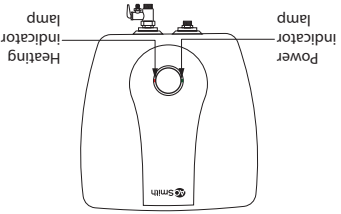

This Water Heater comes with factory pre-set temperature (Refer Page 3). Switch on the Water Heater's power supply. The Power indicator lamp glows.

10

Circuit Diagram

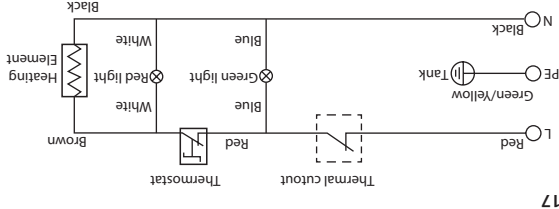

Figure 17

CAUTION

In order to avoid a hazard due to inadvertent re-setting of the Thermal cut-out, this Water Heater must not be supplied through an external switching device, such as a timer, or connected to a circuit that is regularly switched ON and OFF by the utility.

14