

Presenting

Intelli-UV⁺ Hot

Hot is the New Healthy with Smart Purification





A UV water purifier with cutting edge intelligent features and a beautifully crafted design to suit your everyday need. Suitable for water with low TDS (less than 200 ppm or municipal corporation supply, no borewell or tanker supply.)

Instant Hot Water

The Intelli-UV⁺Hot dispenses instant UV purified water at three temperature modes.

 Room Temperature Water

 Warm Water at 45°C

 Hot Water at 80°C for an instant hot beverage

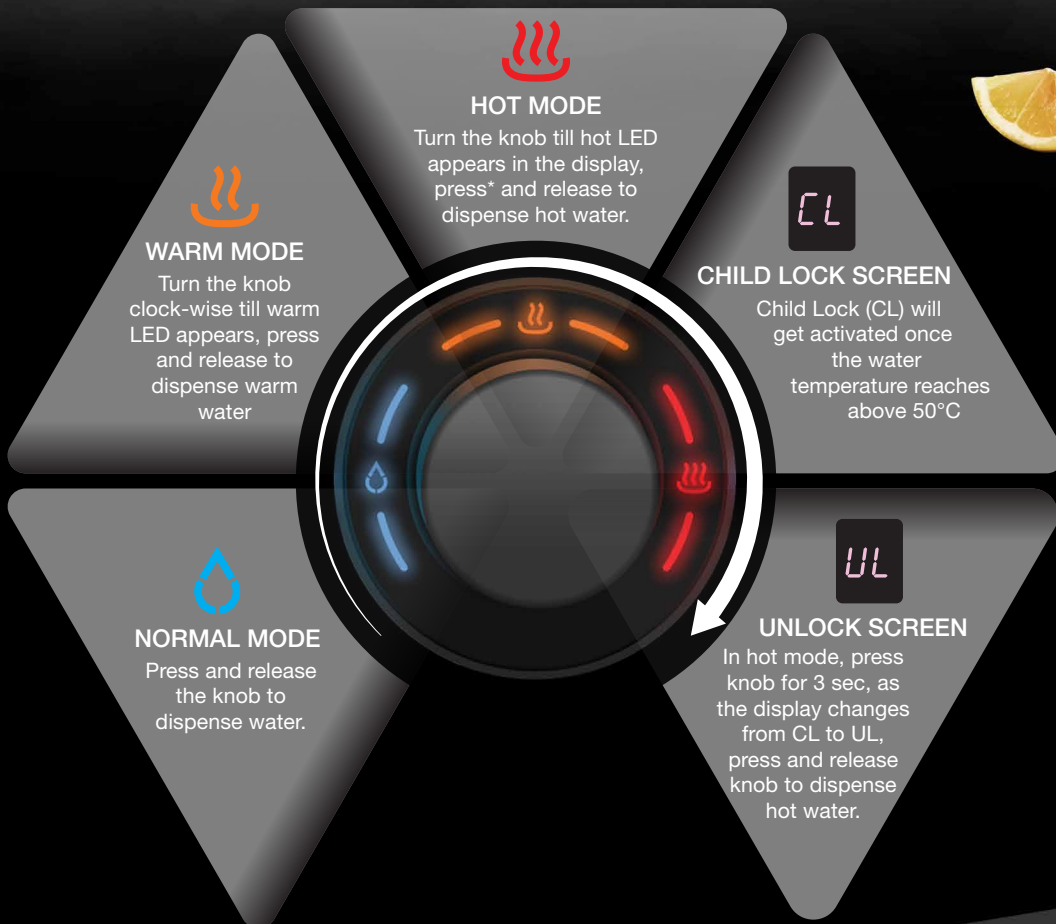

Convenience at your fingertips

Advanced Digital Display with Touch Dispense makes dispensing and monitoring more convenient for you and your family.

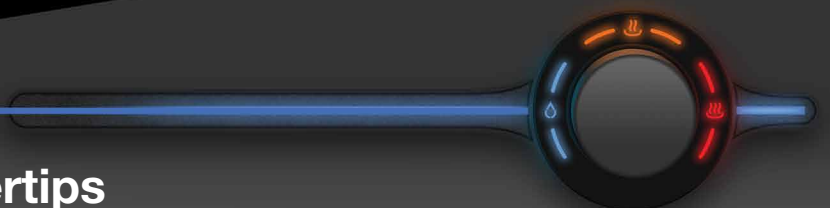

Healthy drinking water with 6 stage purification

A. O. Smith Intelli-UV⁺Hot purifies water through a 6 stage purification process with high power 11 Watt UV + SAPC (Silver Activated Post Carbon) + Lead Shield.

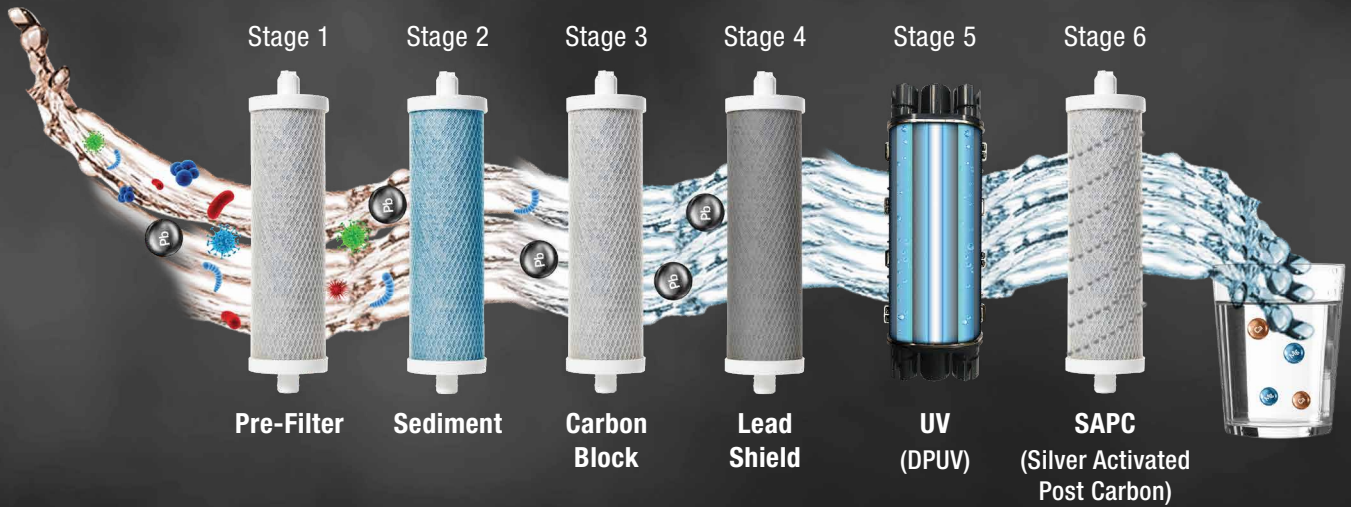

Lead shield

With an added layer of protection to the purification process, the lead shield in the Intelli-UV⁺Hot effectively removes lead and provides you with lead-free, healthy drinking water. Stay worry free as you and your family are safeguarded from the adverse effects of lead poisoning in drinking water with our lead shield technology.

Dual Pass UV chamber (DPUV)

Intelli-UV⁺Hot is powered by India's 1st Dual Pass UV Chamber, a unique design in which the water passes two times through an advanced high power 11W UV lamp, providing double UV purification and ensuring purified safe and healthy drinking water.

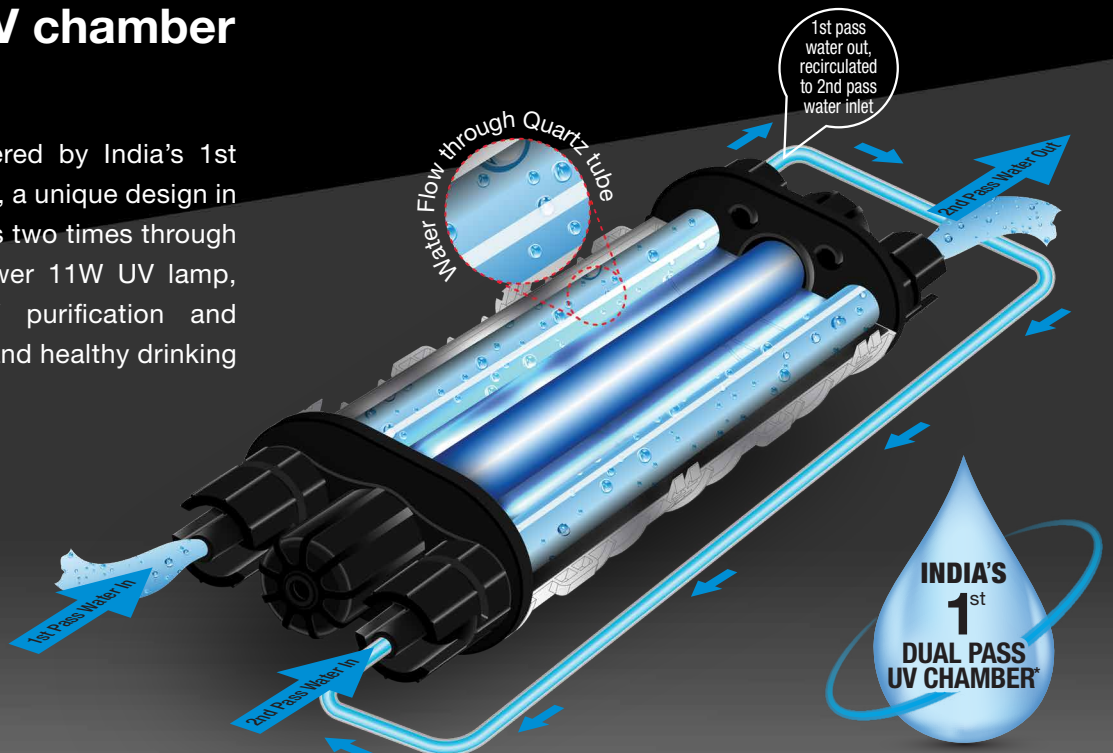

Modern | Contemporary | Sleek & Compact

Elevate your kitchen décor to enhance your experience with sleek, stylish and premium aesthetics, designed to suit your everyday needs.



Intelli-UV ⁺ Hot	
Main Technology	UV+SAPC+Lead Shield
No. of Stages	6
Storage Tank	Upto 3.3 Ltrs
Water Dispensing Type	Touch Dispense
Mounting Options	Wall Mount
Display	LED Display
Dimension (H x D x W) in mm	445 x 191 x 300
Pressure rating in psi*	5 ~ 30
Input Voltage in watt	150 ~ 300V AC / 50 Hz
Power rating in watt (Max)	38
UV lamp power in watt	11
Storage Tank Material	Food Grade

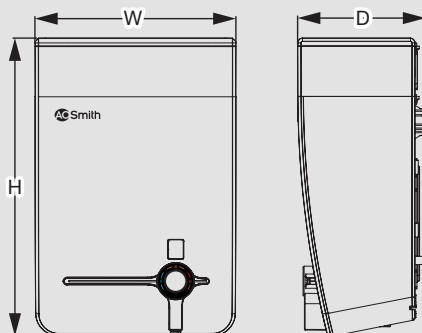

Hot Water at Press of a Button

Instant UV purified water with 3 temperature settings - Room temperature water, warm (45°C) and hot (80°C).



Healthy drinking water with 6 stage purification

6 stage purification with UV + SAPC (Silver Activated Post Carbon) + Lead Shield technology



Double protection with India's 1st Dual pass UV chamber

Intelli-UV⁺Hot is powered by India's 1st Dual Pass UV Chamber which ensures purified safe and healthy drinking water.

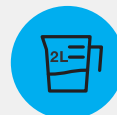

Water filling in a dash

High flow rate of upto 2L/min with storage capacity of upto 3.3 Litres (2.5 Litres Normal + 800 ml Hot).



1 Year Comprehensive Warranty

Peace of mind with 1 Year Comprehensive Warranty.

*If input pressure exceeds 30 psi, a pressure reducing valve needs to be installed at the feed line. If the pressure is lower than 5 psi, a booster pump needs to be installed. *Depending on input pressure. A. O. Smith reserves the right to amend or modify the specifications and features at any time, as and when required without any prior notification.



SCAN IT
TO KNOW MORE

AOSmith

Water Purifiers

Manufactured by

A. O. Smith India Water Products Private Limited

Plot No. 300, Phase - II, KIADB Industrial Area, Harohalli,
Kanakapura Taluk, Ramanagara District,
Karnataka - 562 112, India.

CIN: U31909KA2006PTC040282

Call **1860 500 2468** or visit **www.aosmithindia.com**

<https://www.facebook.com/aosmithin> | <https://twitter.com/AOSmithin> | <https://instagram.com/aosmithindia>