

## Pre-Installation Literature

### On Receipt

It is our policy to promote safe delivery of all orders. This product shipment has been thoroughly checked, packed and quality certified before leaving our factory.

### Visible Loss or Damage

If any of the goods called for on the bill of lading or express receipt are damaged or the quantity is short, do not accept them until the freight or express delivery agent makes an appropriate notation on your freight bill or receipt.

### Concealed Loss or Damage

When a shipment has been delivered to you in apparent good condition, but upon opening the packaging if any loss or damage has taken place while in transit, inform the carrier's agent / A. O. Smith representative immediately.

### About this manual

This manual is a guide to good practice for operating and periodic maintenance of the A. O. Smith Under Sink X5 / X5+ Neo RO Water Purifier.

This does not contain the full servicing procedures necessary for continued successful operation of this product. The services of A. O. Smith Company Authorised Service Technician must be employed periodically on the same. Do not operate before reading manual supplied with this product.

Please follow instructions in this manual to ensure personal safety and proper operation of this product. A. O. Smith assumes no liability for installation or servicing performed by any unauthorised personnel. Always install, operate, inspect and maintain this product in accordance with all applicable standards. Please store this user manual carefully for any future reference.

### Disposal of this Product

(Waste Electrical and Electronic Equipment)



This marking on the product, accessories or User Manual indicates that the product and its electronic accessories (e.g. Remote, batteries and other replaceable electronic accessories) should not be disposed of with other household waste at the end of their working life. To prevent possible harm to the environment or human health from uncontrolled waste disposal, please separate these items from other types of waste and recycle them responsibly to promote the sustainable re-use of material resources.

Household users should contact their local government office, for details of where and how they can take these items for environmentally safe recycling. This product and its electronic accessories should not be mixed with other commercial wastes for disposal.

1

## General Instructions

### Safety

Your safety and the safety of your loved ones is paramount to us. There are several safety related messages in this manual, which have been provided during various steps such as the installation, operation and maintenance of your A. O. Smith Under Sink X5 / X5+ Neo RO Water Purifier. These messages point out potential hazards and also educate on how to reduce any potential risks. Please always read and follow all safety messages as provided in this user manual.

|  |   |
|--|---|
|  | This is the safety alert symbol. This symbol alerts you to potential hazards that can hurt you and others. All safety messages will follow the safety alert symbol and either the word "DANGER" or "WARNING". |
|  | Indicates an imminently hazardous situation which, if not avoided, will result in death or serious injury.  |
|  | Indicates a potentially hazardous situation, which if not avoided, could result in death or serious injury.   |
|  | Indicates a potentially hazardous situation which, if not avoided, may result in minor or moderate injury or property damage.   |

### IMPORTANT

These instructions have been written as a guide for the proper installation and operation of your A. O. Smith Under Sink X5 / X5+ Neo RO Water Purifier. A. O. Smith will not accept any liability where these instructions have not been followed. However, for your safety and to avoid damage caused by improper installation, it is recommended that Water Purifier must be installed by A. O. Smith Authorised Service Technician only.

Before proceeding with the installation instructions:

1. Inspect the A. O. Smith Under Sink X5 / X5+ Neo RO Water Purifier and its component parts for possible damage. Do Not install or attempt to repair any damaged component parts. If you detect any damage in the A. O. Smith Under Sink X5 / X5+ Neo RO Water Purifier, please contact the dealer where the Water Purifier was purchased or call A. O. Smith Customer Care Centre.
2. Verify that the voltage being supplied corresponds to that which is mentioned in the A. O. Smith X5 / X5+ Neo RO Water Purifier manual.

Note: This manual refers to the two models X5 RO Water Purifier and X5+ Neo RO Water Purifier. Based on the product purchased, customer needs to refer the respective illustrations.

2

## Key Features of your A. O. Smith X5 / X5+ Neo RO Water Purifier



### PURITY THROUGH 6 STAGE PURIFICATION

6S TECHNOLOGY: Pre-filter+ART™ MAX + Sediment filter + Carbon block + Side Stream RO + Copper Fortified Mineralizer. In A. O. Smith X5 / X5+ Neo Water Purifier 100% water passes through the RO membrane.



### ADVANCED PATENTED SSM TECHNOLOGY (SIDE STREAM RO MEMBRANE)

Suitable for water with low and high (up to 2000 ppm) TDS. Wastes less water and improves pure water recovery.



### Copper Fortified Mineralizer

Copper fortified mineralizer fortify the goodness of copper and adds essential minerals to the water. This ensures that the water tastes fresh and natural and has balanced pH – an essential requirement for drinking water.



### GOOSE-NECK FAUCET

Swivel faucet for user convenience.



### LARGE STORAGE CAPACITY

Purified water storage capacity of 6 litres.



Product colour and image shown may vary from the actual product. Part No. : 335300-140\_A Date: 13-11-2024



Since 1874

**AO Smith**  
Innovation has a name.

Water Purifier  
**X5 / X5+ Neo**

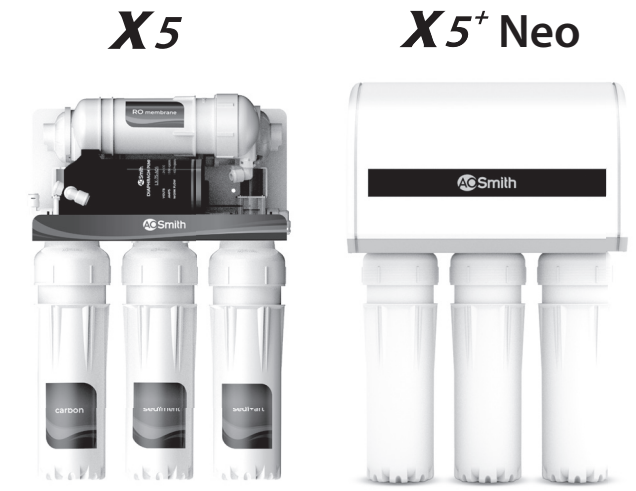

## User Manual

## Introduction

A. O. Smith Under Sink X5 / X5+ Neo RO Water Purifier uses one of the latest technologies that is used in water purification process. A. O. Smith Under Sink X5 / X5+ Neo RO Water Purifier works under the principle of RO (Reverse Osmosis) technology which is found to be one of the most effective process. In this process, water under pressure is passed through a semi-permeable membrane. Purified water is collected for drinking in a storage tank and impurities in the water are flushed to the drain.

### Why water purification is important?

Water purification, today is essential due to the presence of harmful contaminants present in the water supply. Rapid urbanisation and speedy industrial growth have led to significant pollutants and contaminants being found in the water supply. Below is a list of some of the harmful contaminants found today in the water supply which if consumed in excess can be detrimental to human health.

- TDS (Total Dissolved Solids) like Nitrates, Chlorides, Sulphates etc.
- Pesticides and VOC (Volatile Organic Compounds).
- Heavy metals like Mercury, Arsenic, Lead, Chromium, Cadmium etc.
- Microorganisms such as pathogenic bacteria, virus, protozoa and cysts.

A. O. Smith Under Sink X5 / X5+ Neo RO Water Purifier removes excessive TDS (Total Dissolved Solids) in water by more than 95%. A. O. Smith Under Sink X5 / X5+ Neo RO Water Purifier reduces heavy metals and removes pathogens. By this, it ensures you safe and great tasting water.

### How does the A. O. Smith Under Sink X5 / X5+ Neo RO Water Purifier work?

A. O. Smith Under Sink X5 / X5+ Neo RO Water Purifier has 6 stages of purification system, wherein the water is passed through the various stages and progressively filtered to get purified water which is stored in the in-built storage tank.

#### Stage 1 and Stage 2 – Pre-filter + ART™ MAX (Advance Recovery Technology™)

The Pre-filter is used to remove physical contaminants such as dirt, dust, soil particles, turbidity present in the water and ART™ MAX (Advance Recovery Technology™) is scale control media which conditions the water to reduce scaling potential in water. This improves the life of the Sediment filter.

#### Stage 3 – Sediment filter

The Sediment filter is used to remove fine and coarse physical contaminants present in the water. This improves life of the Carbon block.

#### Stage 4 – Carbon block

The Carbon block has high adsorption capacity which reduces harmful chemicals including pesticides, volatile organic compounds, residual chlorine etc., from water. It also adsorbs bad taste and odour causing organic compounds from water.

#### Stage 5 – RO (Reverse Osmosis) membrane

RO membrane contains semi-permeable membrane wherein the water is passed through the semi-permeable membrane to remove TDS (Total Dissolved Solids) and heavy metals like mercury, arsenic, lead, chromium, cadmium etc. It also removes microorganisms like bacteria, virus, protozoa and cysts. The preservative used in the RO membrane is food-grade Sodium meta bi-sulphate.

3

### Stage 6 – Copper Fortified Mineralizer

This filter is the combination of copper fortification technology and MIN-TECH (Mineraliser Technology). Copper fortification technology fortify the goodness of copper in water and act as polisher to enhance the taste of water. MIN-TECH containing Calcium & Magnesium minerals which helps to improve the taste and quality of water, it also adds the required essential minerals back to water and balances the pH of water.

### Installation Overview

Figure 1

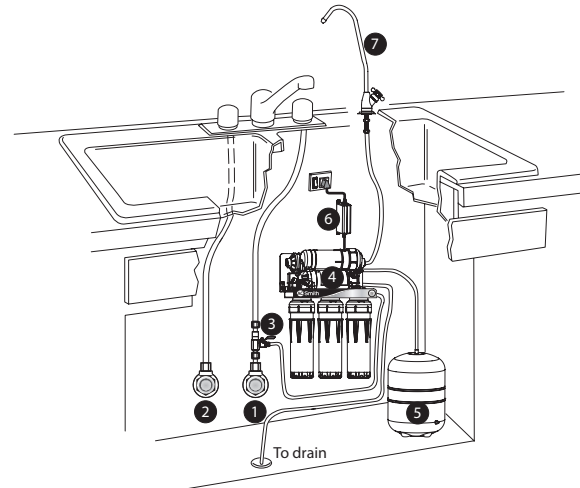

| Part | Description                               |
|------|---|
| 1    | Normal water supply                       |
| 2    | Hot water supply                          |
| 3    | Ball valve                                |
| 4    | Under Sink X5 / X5+ Neo RO Water Purifier |

| Part | Description       |
|------|-------------------|
| 5    | Storage tank      |
| 6    | Power adapter     |
| 7    | Goose-neck faucet |

Note: The Ball valve, Storage tank and Goose-neck faucet comes along with the product as standard accessories.

4

## Water flow

Figure 2

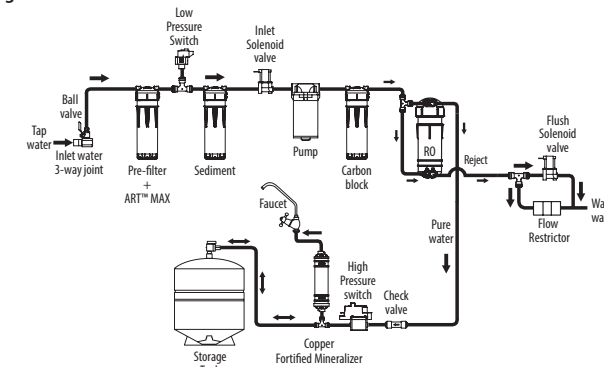

### Flushing Procedure

| Filter                       | Connection  | Flushing process  |
|------------------------------|---|---|
| Carbon block                 | Pre-filter+ART™ MAX>Sediment filter >Pump >Carbon block>Drain                                       | Carbon block flush for 2 minutes.                             |
| Copper Fortified Mineralizer | Pre-filter+ART™ MAX>Sediment filter > Pump >Carbon block > RO > Tank > Copper Fortified Mineralizer | The tank should be filled two times and drain through faucet. |

5

## Electrical diagram

Figure 3

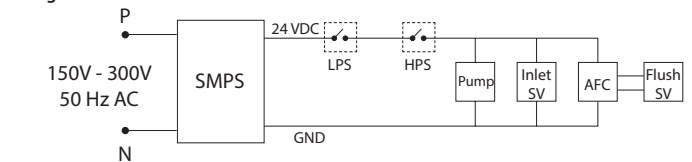

6

## Safety Precautions

### Electrical Safety

Even though this product is designed keeping highest safety standards in mind, there are certain Do's and Don'ts which need to be followed while using this product.

Power plug must be used with a grounded 230 V outlet. It is recommended to connect the product to the power supply only with the plug that is provided with the purifier.

Figure 4

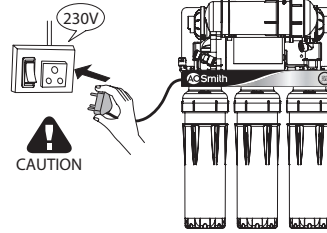

Product should be installed only by A. O. Smith Company Authorised Service Technician. Do not open the purifier for cleaning the filters or for any part replacements. This must be done only by A. O. Smith Company Authorised Service Technician.

Figure 5



Make sure that the feed water is tested before installation (Refer page 9). Do not install the product if the TDS and Hardness are more than that prescribed in the recommended feed water conditions (Refer page 12).

Figure 6

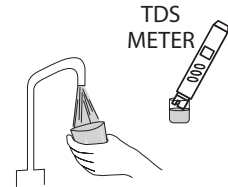

Install the product away from direct sunlight.

Figure 7

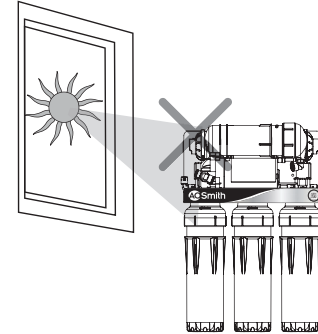

7

Do not connect hot water supply to the purifier. Make sure that the inlet water temperature to the purifier should be between 5°C to 45°C.

Figure 8

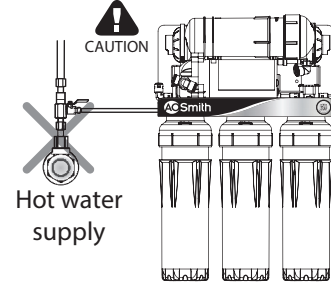

Do not place any chemicals, thinner, soap or any other cleaning items on the purifier.

Figure 9

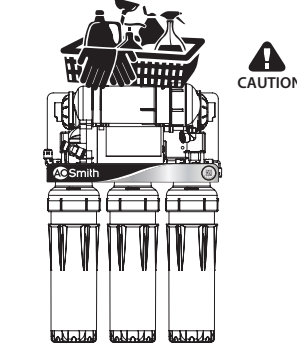

## How to use

1. Turn ON the water connection through the ball valve.

Figure 10

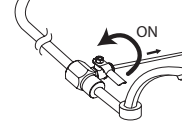

2. Switch ON the power supply.

Figure 11

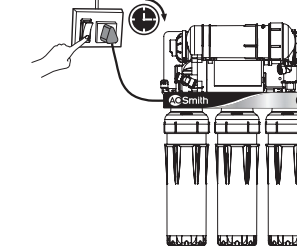

8

3. Turn the faucet knob in anti-clockwise direction to dispense water from the storage tank.

Figure 12

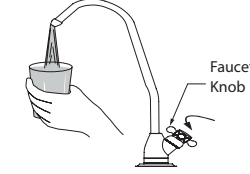

Note:

- Discard the first cycle of pure water, before you start using it for consumption.
- Make sure to discard the water from the storage tank if you have not used the purifier for more than 2 days.

### Cleaning of Tank

Switch off the purifier and drain purified water tank water completely. Bypass the Copper fortified mineralizer filter and connect faucet after the pressure tank. In a beaker or container, dissolve one A. O. Smith disinfectant tablet in 50 ml water and slowly inject dissolved solution slowly drop by drop into the tank using a 50 ml disposable syringe. Upon completion of the transfer of disinfectant solution, close the faucet and switch on the purifier. Allow purifier to fill the tank and keep the system idle for 5 minutes. Discard the water through the faucet and remove any excess water. Switch on the unit and drain one tank of water through faucet before consuming. As per the water flow diagram, reconnect the fortified mineralizer filter in its original position.

Frequency of cleaning: Once in a year along with annual maintenance.

### How to use TDS meter?

- Insert the button cell inside the TDS meter.
- Switch ON the TDS meter.
- Fill water in the cap and immerse the TDS meter.
- Press the HOLD button and take it out of the water to view the reading.
- If the meter displays the 'x10' symbol, it means that you must multiply the reading by 10.
- Remove the button cell from the TDS meter when not in use.

### Calibration and Maintenance of TDS meter

The TDS meter are factory-calibrated and designed to stay consistent. Maintenance of the TDS meter will be done along with the yearly product maintenance.

9

## Troubleshooting

Your A. O. Smith Under Sink X5 / X5+ Neo RO Water Purifier may not function at its desired capability if used incorrectly. This may not necessarily mean that the product is faulty. For instances like these, please follow the steps given below to troubleshoot the problem without the help from a certified technician. If the problem still persists, please call Customer Care Centre immediately.

| Problems                         | Possible Cause(s)   | Solution   |
|----------------------------------|---|--|
| Change in water taste            | Has the purified water been stored in the tank for long time? | Drain the stored water from the storage tank through faucet.     |
|                                  | RO membrane / filters may require replacement.                | Call Customer Care Centre for RO membrane / filters replacement. |
|                                  | Has the raw water quality changed?                            | Call Customer Care Centre.                                       |
| Decreased flow of purified water | Check if there is no water flow through reject line.          | Switch OFF the Water Purifier and call Customer Care Centre.     |
|                                  | Check whether the tap/ ball valve is closed.                  | Open the tap/ball valve.   |
| Less / No reject water.          | RO membrane / filters may be clogged or damaged.              | Call Customer Care Centre for RO membrane / filters replacement. |
|                                  | Check if the reject water tube is bent.                       | Clear the bent in the reject water tube.                         |
|                                  | Check if the reject water tube is blocked.                    | Switch OFF the Water Purifier and Call Customer Care Centre.     |

10

| Problems                  | Possible Cause(s)                                     | Solution  |
|---------------------------|---|---|
| Less / No purified water. | Check whether there is water supply in the tap.       | If not, take the help of a plumber to set it right. |
|                           | Check whether tap/ball valve is closed.               | Open the tap/ball valve.                            |
|                           | Water is completely drawn from the storage tank.      | Wait until the storage tank gets filled.            |
| No Auto flush             | None of the above.                                    | Call Customer Care Centre.                          |
|                           | Auto flush controller / Flush solenoid valve failure. | Call Customer Care Centre.                          |

Note: Call Customer Care No. 1860-500-2468.

11

## Technical Specifications

| Model                                      | A. O. Smith Under Sink X5 / X5+ Neo RO   |                          |
|--|--|--------------------------|
| Product Dimensions (H x D x W)             | X5   | 455 mm x 195 mm x 290 mm |
|  | X5+ Neo  | 455 mm x 200 mm x 310 mm |
| Net Weight                                 | X5   | 8.5 kgs (approx.)        |
|  | X5+ Neo  | 9.0 kgs (approx.)        |
| Gross Weight                               | X5   | 12.5 kgs (approx.)       |
|  | X5+ Neo  | 13.0 kgs (approx.)       |
| Production rate*                           | Upto 15 litres per hour  |                          |
| Storage tank capacity†                     | 6 litres (approx.)   |                          |
| Purification technology                    | RO (Reverse Osmosis)   |                          |
| 6 Stage Purifying Technology               | Pre-filter+ART™ MAX + Sediment filter + Carbon block + Side Stream RO + Copper Fortified Mineralizer |                          |
| Membrane type                              | Thin film composite RO membrane  |                          |
| Material of construction for plastic parts | Food safe, non-toxic, engineering grade plastics   |                          |
| Pump type                                  | Diaphragm pump, 24VDC, 0.26 Amps, Operating Pressure 125 psi (Max.)                                  |                          |
| Input Voltage                              | 150 – 300 VAC, 50 Hz   |                          |
| Power rating (Max)                         | 48 Watts   |                          |
| Pressure Rating***                         | 7 psi to 30 psi  |                          |
| % Recovery**                               | Minimum 40%  |                          |
| TDS reduction**                            | ≥95% (approx.)   |                          |
| Input water temperature                    | 5°C to 45°C  |                          |

\* Production rate depends on variable factors such as feed water pressure, feed water characteristics and condition of the filters.

\*\* TDS reduction percentages also depends on variable factors such as life and condition of the filters, feed water pressure, feed water characteristics etc.

\*\*\* If input pressure exceeds 30 psi, a pressure reducing valve needs to be installed at

12

the feed line. If the pressure is lower than 7 psi, a booster pump needs to be installed. Ensure you buy them from A. O. Smith Company Authorised Service Technician.

† Storage tank capacity depends on the storage tank bladder pressure.

Recommended input feed water quality for the optimum performance of your product

| *Recommended Feed Water Quality |  |
|---------------------------------|--|
| Parameter                       | Limits                                   |
| Total Dissolved Solids (TDS)    | Up to 2000 ppm                           |
| Total hardness                  | Up to 500 ppm                            |
| Turbidity                       | Up to 5 NTU                              |
| Iron                            | 0.3 ppm (max.)                           |
| Feed water pressure             | 7 psi to 30 psi / 0.048 Mpa to 0.206 Mpa |
| Feed water temperature          | 5°C to 45°C                              |

Caution: The RO system is not recommended for arsenic level above 0.1 mg/litre, fluoride level above 8.0 mg/litre and iron level above 0.3 mg/litre.

\*The performance of the all filters depends on the input water conditions as mentioned above.

### Warranty details/recommended filter change:

As per the warranty, all the filters, including RO membrane needs to be replaced after 6000 litres of water consumption or 1 year whichever comes first.

| Consumable Filters            | Average Service Life |
|-------------------------------|----------------------|
| Pre-filter+ART™ MAX           | 6000 litres*         |
| Sediment filter               | 6000 litres*         |
| Carbon block                  | 6000 litres*         |
| Side Stream RO membrane       | 6000 litres*         |
| Copper Fortified Mineralizer* | 6000 litres*         |

\*The filter media used will not cause any of the parameters in the purified water to exceed acceptable limits specified in IS 10500 (2012).

\*As per standard test conditions. Filters are designed for 6000 litres of purified water.

13

## Frequently asked questions (FAQs)

- What is A. O. Smith Under Sink X5 / X5+ Neo RO Water Purifier?**  
A. O. Smith Under Sink X5 / X5+ Neo RO Water Purifier is advanced 6 stages RO from A. O. Smith. It is 100% RO with no bypass of water for maximum purity.
- What is 100% RO?**  
In ordinary RO+UV Water Purifiers, some amount of water is made to bypass the RO membrane. With this, heavy metals, unwanted salts and pesticides also pass through. In A. O. Smith Under Sink X5 / X5+ Neo RO Water Purifier, 100% of the water is passed through the RO membrane which ensures maximum purity of water.
- How many stages A. O. Smith Under Sink X5 / X5+ Neo RO has? And what are the stages?**  
A. O. Smith Under Sink X5 / X5+ Neo RO Water Purifier has 6 stages of purification which are Pre-filter+ART™ MAX + Sediment filter + Carbon block + Side Stream RO + Copper Fortified Mineralizer.
- What is the storage capacity in the A. O. Smith Under Sink X5 / X5+ Neo RO Water Purifier?**  
The storage capacity in the A. O. Smith Under Sink X5 / X5+ Neo RO Water Purifier is 6 litres of pure water.
- What is the purification Production rate of A. O. Smith Under Sink X5 / X5+ Neo RO Water Purifier?**  
Upto 15 litres per hour, purification capacity also depends on water quality, condition of filters, storage tank bladder pressure and RO membrane.
- What is the Advanced SSM technology? How is it different from other technologies and what are its advantages?**  
The Advanced SSM is an abbreviation for the side stream RO membrane technology. Unlike traditional membranes, this membrane has water inflow from 2 sides which results in better rejection of dissolved solids. It also results in higher membrane life.

14