

## Pre-Installation Literature

### On Receipt

It is our policy to promote safe delivery of all orders. This product shipment has been thoroughly checked, packed and quality certified before leaving our factory.

### Visible Loss or Damage

If any of the goods called for on the bill of lading or express receipt are damaged or the quantity is short, do not accept them until the freight or express delivery agent makes an appropriate notation on your freight bill or receipt.

### Concealed Loss or Damage

When a shipment has been delivered to you in apparent good condition, but upon opening the packaging if any loss or damage has taken place while in transit, inform the carrier's agent / A. O. Smith representative immediately.

### About this manual

This manual is a guide to good practice for operating and periodic maintenance of the A. O. Smith Ecosmart H Water Heater. Do not operate the Water Heater before reading the user manual.

Please follow instructions in this manual to ensure personal safety and proper operation of this product. Always install, operate, inspect and maintain this product in accordance with all applicable standards. Please store this user manual carefully for any future reference.

### Disposal of this Product

(Waste Electrical and Electronic Equipment)



This marking on the product, accessories or User Manual indicates that the product should not be disposed of with other household waste at the end of their working life. To prevent possible harm to the environment or human health from uncontrolled waste disposal, please separate these items from other types of waste and recycle them responsibly to promote the sustainable re-use of material resources.

Household users should contact their local government office, for details of where and how they can take these items for environmentally safe recycling. This product and its electronic accessories should not be mixed with other commercial wastes for disposal.

1

## Specifications

SKU	Ecosmart H	
Model number	HE1102KWQ323	HE1152KWQ324
Volume [L]	10	15
Power [W]	2000	
Voltage/Frequency [V/Hz]	230~/50	
Actual Stdg. LosskWh/24h/45°C diff.]	0.332	0.381
Reheating time for 35°C rise [in min.]	11	16
Temperature range [°C]	25-75*	
Max. inlet water pressure (MPa)	0.8	
Inlet/Outlet connections [inch]	½ BSP	
Net Weight (Kg)	7.3	9.5

\*The maximum set temperature may vary ± 5 °C.

### Dimensions

Model	10 L	15L	Model	10 L	15L
A (mm)	310	310	D (mm)	185	199
B (mm)	437	576	E (mm)	75	149
C (mm)	144	144	F (mm)	318	334

Figure 1

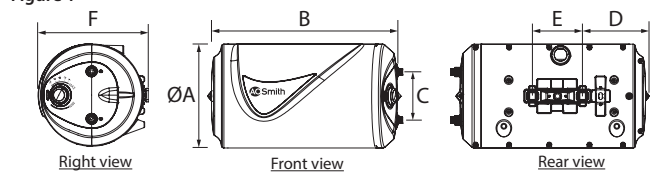

Note: The above configuration is available in Left Hand Side (LHS) (only in Ecosmart H 15L model).

3

## General Instructions

### Safety

Your safety and the safety of your loved ones is paramount. There are several safety related messages in this manual, which have been provided during various steps such as the installation, operation and maintenance of your Ecosmart H Water Heater. These messages point out potential hazards and also educate on how to reduce any potential risks. Please always read and follow all safety messages as provided in this user manual.

	This is the safety alert symbol. This symbol alerts you to potential hazards that can hurt you and others. All safety messages will follow the safety alert symbol and either the word "DANGER" or "WARNING".
	Indicates an imminently hazardous situation which, if not avoided, will result in death or serious injury.
	Indicates a potentially hazardous situation, which if not avoided, could result in death or serious injury.
	Indicates a potentially hazardous situation which, if not avoided, may result in minor or moderate injury or property damage.

### WARNING

Do not use this Water Heater if any part has been under water. Immediately contact an Authorised Service Provider to inspect the Water Heater and replace any part of the control system which has been under water. Failure to follow this instruction can result in property damage, serious injury or death.

### IMPORTANT

These instructions have been written as a guide for the proper installation and operation of your Water Heater. A. O. Smith will not accept any liability where these instructions have not been followed. However, for your safety and to avoid damage caused by improper installation, it is recommended that Water Heater must be installed by an Authorised Service Provider.

Before proceeding with the installation instructions:

1. Inspect the Water Heater and its component parts for possible damage. Do Not install or attempt to repair any damaged component parts. If you detect any damage in the Water Heater, please contact the dealer where the Water Heater was purchased or call Customer Care Centre.
2. Verify that the voltage being supplied corresponds to that which is marked on the Water Heater manual.

2

Figure 2

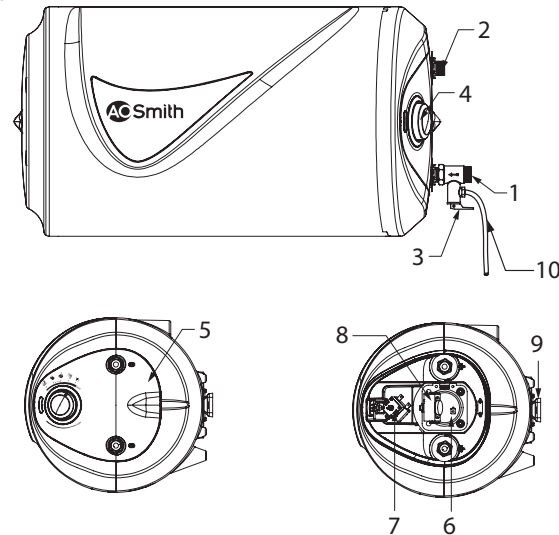

With Service Cover

Without Service Cover

Note: The above image shows is Right Hand Side model.

PART	DESCRIPTION	PART	DESCRIPTION
1	Cold water inlet	6	Heating element and Anode
2	Hot water outlet	7	Thermostat
3	Multi-function safety valve*	8	Thermal cut-out
4	Temperature control knob	9	Wall mount bracket
5	Service cover	10	Discharge tube*

\*Note: The Multi-function safety valve, Discharge tube and Mounting accessories come along with the product as standard accessories.

4



Since 1874

Product colour and image shown may vary from the actual product.  
Part No. : 335300-200\_A Date: 24-07-2025

## Safety Precautions

### During Installation

Do not install the Water Heater where there is direct sunlight or rain. It is has to be installed indoors only.

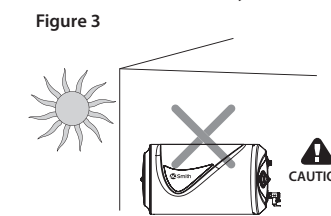

Do not install the Water Heater where water splashes on the Water Heater.

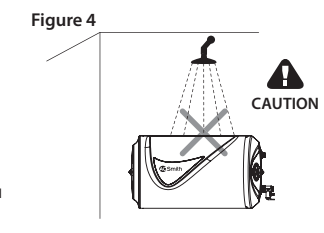

## Installation

Before installing, ensure the tools Adjustable wrench, Teflon tape, Measuring tape, Hammer, Bubble level indicator and Impact drill tool are available.

### Mounting the Water Heater

- It is recommended as per IS302-1 to have 6 inches clearance from wall.
- Select a place to mount Water Heater horizontally with water connection at the bottom.
- Water Heater must be located within 2.5 ft. (approx.) from a 230 V electrical outlet with proper grounding.
- Make sure that the wall can withstand at least twice the weight of the Water Heater when completely filled with water.

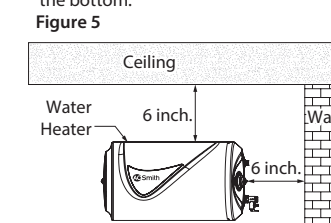
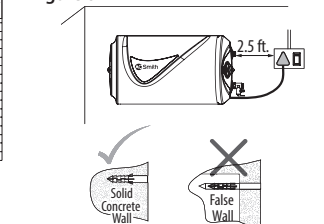

Figure 6



5

AC Smith  
Innovation has a name.

Water Heater  
ECO SMART  
H 10 and 15 Litres

# ECO SMART



## User Manual

Use a drill bit with diameter of 12 mm to drill 2 holes at least 90 mm deep in the wall (Step 3). The two holes should be aligned horizontally. The horizontal distance between 2 holes is shown in Page 3 (Refer Dimensions table).

Figure 7

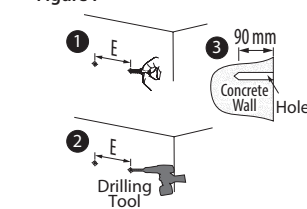

• Insert the Expansion Anchor into the hole (Step 1).  
• Insert the Hanging screw over the Expansion Anchor and tighten the Hanging screw by rotating it till it gets fixed steadily (Step 2).

Figure 8

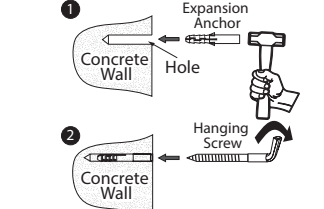

Mount the Water Heater on the Hanging screw through Wall mount bracket. Tug downwards on the Water Heater to ensure that the Water Heater is fixed steadily.

Figure 9

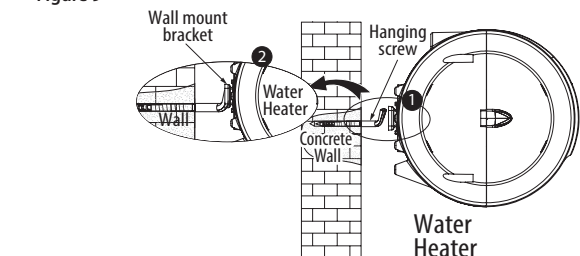

### DANGER



Scalding

Hot water is dangerous, especially for the young children, aged or the disabled. The Water Heater allows you to control the temperature of your hot water. Water temperatures over 52°C can cause severe burns instantly or death from scalds. Do not leave a child or an infirm person in the bath unsupervised.

6

## Connecting Multi-function Safety valve

Wrap the threaded part of the cold water inlet pipe with Teflon tape in clockwise direction.

Figure 10

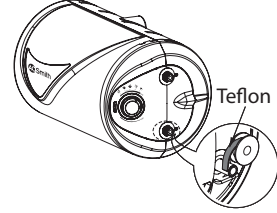

Connect the Multi-function Safety valve to cold water inlet pipe and rotate it in clockwise direction till it gets fixed.

Figure 11

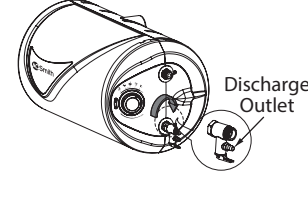

Note: The Multi-function Safety valve may drip during the usage of the heater. As the water is heated, it expands and tries to flow back through the inlet pipe but is prevented by the presence of the non-return valve (an external valve provided before cold water tap). Hence water may drip from the Multi-function Safety valve. Therefore, Discharge Outlet is provided to discharge water from the Water Heater. To avoid dripping, it is recommended to install non-return valve at a distance of at least 40 feet away from the inlet of the Water Heater.

### CAUTION

- The Multi-function Safety valve should never be removed or blocked by any means to prevent it from dripping or releasing the excess pressure inside the heater. Failure to do so may result in damage to the Water Heater and injuries to the user. This will also make the warranty null and void.
- Discharge Outlet is provided to release the discharge from the Water Heater in case excessive pressure is developed. The contents of the discharge from the Multi-function Safety valve may be hot and may cause burns to the users and damage nearby objects, therefore it is recommended to take precautions.
- It is recommended to operate the Discharge lever in the Multi-function Safety valve on a regular basis to ensure that there are no blockages and also to remove any lime deposits that would have been formed inside the Water Heater.
- Ensure that the Water Heater is in power OFF condition when the Discharge Lever is being operated. Ensure that the water is filled completely in the Water Heater before switching it ON.
- Ensure that the Multi-function Safety valve is not damaged while tightening.

7

## Connecting to Water Supply

Figure 12 Installation Diagram

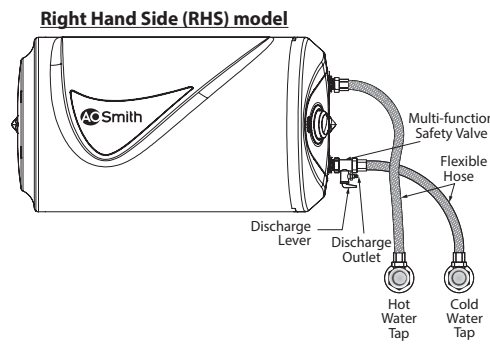

Left Hand Side (LHS) model

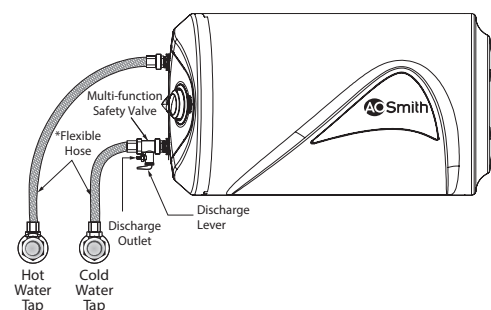

Note: Left Hand Side (LHS) model available only in Ecosmart H 15L.

- Make necessary plumbing with reference to the Installation Diagram (Refer "Installation Diagram").
- A. O. Smith recommends Nylon/ Stainless Steel (SS) braided hoses (Flexible Hoses) having a minimum pressure rating of 8 Bar and hoses should be compatible for hot water applications.
- Connect the cold water pipe to the inlet [Blue Sticker].
- Connect the hot water pipe to the outlet [Red Sticker].

8

### CAUTION

- Make sure a suitable Teflon tape is used for all plumbing connections to prevent leakage.
- Use only Nylon/ Stainless Steel (SS) braided hoses (Flexible Hoses) having a minimum pressure rating of 8 Bar and hoses should be compatible for hot water applications.
- Failure to follow this instruction can result in property damage.

## Operation

### Filling the Water Heater Tank

Figure 13



- Open a nearby hot water faucet to permit air to escape.
- Open the cold water inlet valve fully, filling the Water Heater and the piping.
- Close hot water faucet when water flows.
- Check all the connections to see if there is any leakage. In case of a leakage, drain the water completely, repair the leaking joint and then refill the Water Heater.

### CAUTION

- This Water Heater should not be operated with insufficient amount of water. Failure to do so may result in damage to the Water Heater and injuries to the user. This will also make the warranty null and void.
- Once the Mounting, Multi-function Safety valve, Plumbing and Water filling is completed, then only the power supply should be switched ON.
- Do not splash water directly or clean with benzene, pesticides, thinner, alcohol, etc., but use a soft, dry cloth to clean the Water Heater.

### Connecting to Electrical Supply

Figure 14

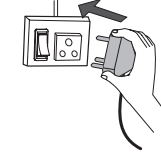

The power cord and plug are connected with this Water Heater. Find a separate socket for power plug and make sure the socket is in firm contact with the plug. Ensure that reliable earthing has been done.

9

Note: If a stationary appliance is not fitted with a supply cord and a plug, or with other means for disconnection from supply mains having a contact separation in all poles that provide full disconnection under overvoltage category III conditions, means for disconnection must be incorporated in the fixed wiring in accordance with the wiring rules.

### CAUTION

- Connect the Water Heater using independent sockets, do not use any adapters. Use multimeter to check whether the live line and neutral line are not reverse, to ensure complete safety.
- Before installing the Water Heater, confirm that the power of Water Heater matches electric meter capacity and supply wire.
- The Water Heater should be earthed reliably. It is prohibited to connect the earth wire to neutral wire or faucet water pipe.
- If the power supply cord is damaged, it must be replaced by the manufacturer or Authorised Service Provider in order to avoid a hazard.

### Temperature Control Knob

Figure 15

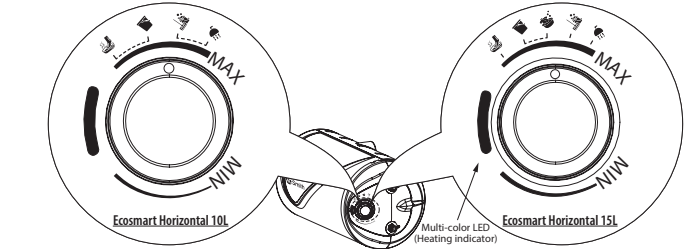

Switch on the Water Heater's power supply. The Heating indicator LED glows as shown in "Figure 15".

### Temperature Setting

Turn the Temperature control knob clockwise for the device to commence heating and change the set temperature [The set temperature increases if the Temperature control knob is turned clockwise]. Temperature can be adjusted from 25°C to maximum 75°C.

### Smart Modes

There are 5 types of smart modes which are shown below. These modes vary with capacity. Mode selection is done by pointing the mark on the knob to the preferred application.

**Pedicure:** This mode is used to Pedicure your feet.

**Bucket:** This mode is used for single Bucket bath.

10

<b>Washing:</b> This mode is used for Washing clothes (Only for 15L model).	<b>Mopping:</b> This mode is used for Mopping the floor.
<b>Shower:</b> This mode is used for single Shower bath.	

### Notes:

- All the smart modes are tested at factory settings with an ambient temperature of 25°C, under controlled conditions.
- For all prescribed modes, the application temperature has been arrived at by mixing hot water from the water heater with 50% or more of ambient water by volume.
- For Shower bath, Bucket bath and Pedicure applications, water temperature of 38°C to 40°C is considered.
- For Washing and Mopping applications, water temperature of 45°C to 50°C is considered.
- Customers are advised to vary the mixing based on ambient conditions and personal preferences to get the desired application temperature.
- Pedicure, Bucket, Shower and Mopping modes are available in both the models. Washing mode is available only in 15L model.

### CAUTION

It is recommended to mix the hot water from the water heater with ambient water before usage to prevent scalding.

### Modes

There are two types of modes depending on the actual water temperature inside the inner tank of the Water Heater:

Heating mode	Standby mode
When the actual temperature of the water is less than the set temperature, it enters into Heating mode. The Heating indicator LED glows in blue colour as shown in "Figure 16".	After the Water Heater reaches set temperature, it will enter into the Standby mode due to the thermostat cut-off, the Heating indicator LED glows in red colour as shown in "Figure 17".
Figure 16 	Figure 17 

11

When the temperature of the water drops by 5°C from the set temperature due to usage of water, the Water Heater again enters into the Heating mode.

### Draining the Water Heater Tank

Whenever the water heater is not used for an extended period, unplug the unit and drain all the water. Additionally, drain the water heater completely to prevent freezing when the water heater is left unused during winters with sub-zero temperatures.

Figure 18

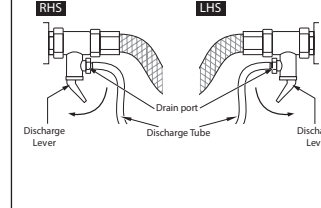

- Switch OFF the electric supply to the Water Heater.
- Open the hot water faucet until the water runs cool.
- Close cold water supply.
- Attach the Discharge Tube to the Drain Port on the Multi-Function Safety Valve (Refer "Figure 18").
- Drain the water by lifting the Discharge Lever of the Multi-function Safety valve upwards (Refer "Figure 18").

### CAUTION

Please turn off the power supply to the Water Heater prior to draining the Water Heater.

## Troubleshooting

The Water Heater may not operate as desired if used incorrectly or there is a minor cause, even though the product has no fault. In these cases, check the following issues to solve simple problems without the help from the Customer Care Centre. If the problem does not solve after checking the following issues, call Customer Care Centre.

Problems	Possible Cause(s)	Solution
Heating indicator LED does not glow and no hot water.	No power supply to the Water Heater.	Check power supply and switch ON electrical switch.
	Thermal Cut-out has tripped or problem in internal wiring error.	Call Customer Care Centre.
Heating indicator LED glow but no hot water.	Heating Element breakdown or internal wiring error.	Call Customer Care Centre.
Water temperature is too high.	Improper thermostat operation.	Call Customer Care Centre.
	Thermal cut-out not operating.	Call Customer Care Centre.

12

Problems	Possible Cause(s)	Solution
Water heats slowly.	Low Voltage at supply mains.	Call Customer Care Centre.
	Scale deposition.	Call Customer Care Centre.
Piping connection leaks.	Connection not sealed.	Re-connect piping, using Teflon tape.
Water leakage from product.	Leakage in tank or other parts.	Switch OFF power immediately and Call Customer Care Centre.
Water dripping from Multi-function Safety valve during heating.	Non-return valve is installed close to the inlet of the Water Heater.	Install Non-return valve at a distance of at least 40 feet from the inlet of the Water Heater (Refer page 7), if problem still persists call Customer Care Centre.
Foul smell from hot water.	Presence of organic matter in input water.	Provide treated water at the input.
	No usage of hot water for a long time period	If the Water Heater is not used for an extended period of time, drain the water from the Water Heater. Ensure water is filled back before use of Water Heater.
	High electrical conductivity of water due to dissolved solids in input water.	Call Customer Care Centre. Anode options available for highly conductive water.

Note: Call Customer Care No. 1860-500-2468.

13

## Circuit Diagram

Figure 19

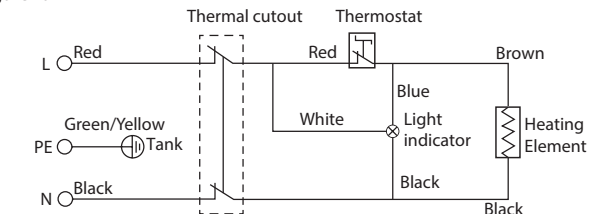

### CAUTION

In order to avoid a hazard due to inadvertent re-setting of the Thermal cut-out, this Water Heater must not be supplied through an external switching device, such as a timer, or connected to a circuit that is regularly switched ON and OFF by the utility.

14